

Rigel HV Portable Yellow Laser Module

Laserglow Part Number: GRH005XXX



Similar Products:

For information about the other lasers in this product family visit:

<http://www.laserglow.com/GRH>

Ordering:

Order Online Now or Request Quote:

<http://www.laserglow.com/GRH005XXX>

Series Specifications:

Nominal Wavelength	589 nm
Output Type	Pulsed (720 Hz)
Laser Source Type	DPSS

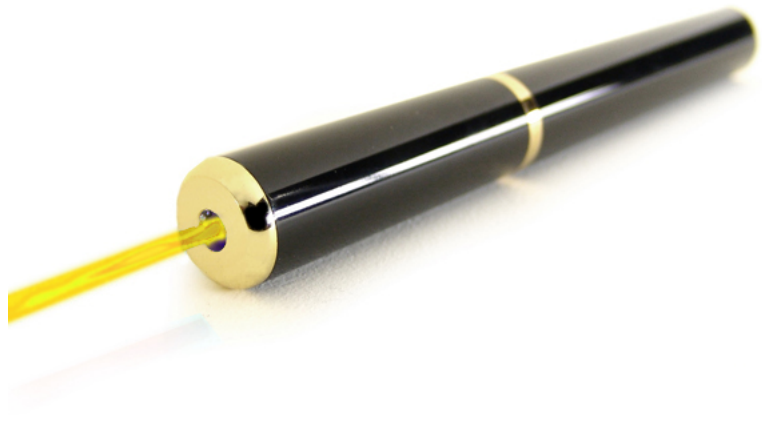

Overview:

The new 589 nm bright yellow pointer from Laserglow is noticeably brighter and more "yellow" than the original 593.5 nm Rigel series yellow lasers. (The regular Rigel is often described as "amber-yellow".) This wavelength is closer to the middle of the spectrum, making it brighter to the human eye and more suitable for presentations on bright projection screens or long-range pointing applications. This is really the brightest and "yellowest" yellow pointer on the market!

Key Features:

- **Starting at: \$689**
- **Output Power:** 2.0 mW - 4.9 mW, varies based upon model
- **Expected Life:** 3000-5000 hours
- **Wavelength:** 589 nm (yellow)
- **Key Feature:** The brightest yellow laser on the market!
- **Casing:** Solid Brass
- **Package Includes:** Portable laser, aluminum carrying case, instructions/warranty.
- **Safety Info:** Models below 5 mW comply with Class IIIa regulations.
- **Duty Cycle:** 30 sec. on/15 sec. off

Specifications:

This spec sheet has been generated specifically for part number GRH005XXX, per your request, and data for the entire series is also displayed for your reference. The specs which are specific to GRH005XXX have been highlighted below in **red + bold**.

Laser Form Factor	GAP
Output Power (mW)	<2, <5
FDA Safety Class	IIIa
Central Wavelength (nm)	588.6
Divergence (mrad, full angle)	<1.5
Beam Dimensions (mm, 1/e ²)	1.5
Transverse Mode	TEM00
Longitudinal Modes	Multiple
Operating Temperature Range (°C)	15 to 35
Storage Temperature Range (°C)	-10 to 50
Total Power Consumption (W)	2
Max. Power Input Duty Cycle	30 sec. on/15 sec. off
Cooling Method	Passive Air
Standard Warranty (months)	6
MTTF (operational hours)	5000
Weight of Product or Laser Head (kg)	0.1
Dimensions of Product or Laser Head (mm)	150 (l) x 16.5 (d)
Power Supply	1 x CR2 Battery

CW: All specifications are based on performance at full output power and after the specified warmup period. Output characteristics may change if the laser is run at a different power level.

Q-Switched: Specifications are based on the laser pulsing at the specified design frequency. Output characteristics may change if the laser is run at a different frequency.

Regulatory Classification:

The model you have selected (GRH005XXX) requires the following safety label(s):



Dimensional Drawing - Laser Form Factor: GAP:

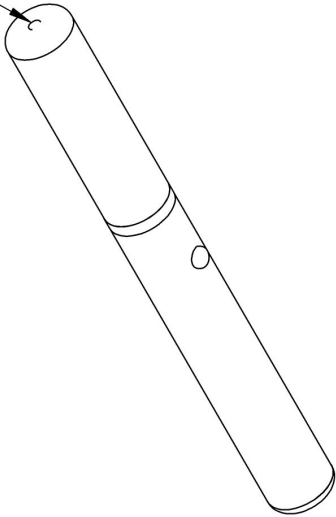
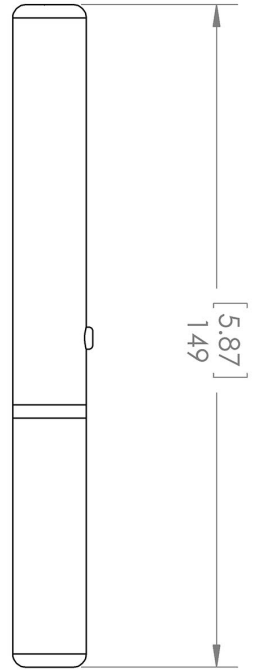
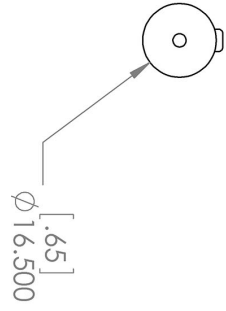
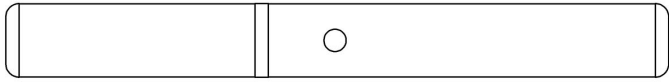

Aperture

UNLESS OTHERWISE SPECIFIED:
DIMENSIONS ARE IN MM(INCH)
TOLERANCES: +/- 0.75 MM

THE INFORMATION CONTAINED IN THIS DRAWING IS THE SOLE PROPERTY OF LASERGLOW TECHNOLOGIES. ANY REPRODUCTION IN PART OR AS A WHOLE WITHOUT THE WRITTEN PERMISSION OF LASERGLOW TECHNOLOGIES IS PROHIBITED. © 2012 LASERGLOW.COM LIMITED. ALL RIGHTS RESERVED

Laserglow Technologies

TITLE:
**Aquarius /
Rigel HV /
Electra / Hydra**
REV
1

SCALE: 2:3

SHEET 1 OF 1

Accessories:

The most popular accessories for model GRH005XXX are shown below. For additional details regarding these or other accessories please see our website or contact us directly.

Part Number	Description	
-------------	-------------	--

FOR MORE INFORMATION PLEASE CONTACT:

LASERGLOW TECHNOLOGIES
99 Ingram Dr. Unit B, North York, ON, Canada M6M2L7
Tel. (416) 729-7976 Fax (480) 247-4864
sales@laserglow.com www.laserglow.com

E&OE: Data included in this sheet may be subject to change without notice.
Please confirm critical specifications with our staff prior to ordering.