

Brightline Premium Cross-Projecting Laser

Laserglow Part Number: BCH005342

Similar Products:

For information about the other lasers in this product family visit:

<http://www.laserglow.com/BCH>

Ordering:

Order Online Now or Request Quote:

<http://www.laserglow.com/BCH005342>

Series Specifications:

Nominal Wavelength	520 nm
Output Type	CW
Laser Source Type	Diode



Overview:

The Brightline Premium Series of Lasers are ideal for any application where highly visible projections, such as lines, dots, crosses, complex patterns, need to be projected onto a surface. These diode lasers are designed to withstand day to day use in harsh industrial environment. The waterproof aluminum and brass housing protect the laser diode, electronic circuitry and precision optics. These lasers incorporate focus-adjustable optics, greatly increasing the precision for tasks requiring the highest level of accuracy or greater working distance.

Key Features:

- Output Power: Up to 80 mW
- IEC Safety Classification: 3R (no additional safety eyewear required)
- Minimum achievable spot/line size: 25 mm at 30 cm
- Package Includes: Laser mounted in block, adjustable mounting bracket for easy positioning of projection onto a surface, and 110/240V AC power supply
- Available Projection Colors: Red, Green, Blue, Violet
- Projection Type: Line, Dot, Cross
- Casing: Machined Aluminum anodized Red
- Water Resistant: IP67
- Operating Temperature Range: 0° to 120°F (-20°C to 50°C)
- Operating Life: 8,000+ hours of continuous use

Specifications:

This spec sheet has been generated specifically for part number BCH005342, per your request, and data for the entire series is also displayed for your reference. The specs which are specific to BCH005342 have been highlighted below in **red + bold**.

Laser Form Factor	B9
Output Power (mW)	5, >20, >40, >80
Output Power Stability (%RMS/4h)	<10
IEC Safety Class	2, 3R
Projection Type (See below for detail)	Cross
Projection Fan Angle (°, full angle)	52
Divergence (mrad, full angle)	<0.3
Beam Dimensions (mm, 1/e ²)	7
Minimum Achievable Beam Diameter	0.25 mm at 0.3 m
Transverse Mode	Near TEM00
Longitudinal Modes	Multiple
IP rating	67
Operating Temperature Range (°C)	-20 to 50
Storage Temperature Range (°C)	-20 to 50
Max. TTL Modulation Freq. (Hz)	500
Modulation Input Signal	0-5 VDC
Total Power Consumption (W)	1
Max. Power Input Duty Cycle	100
Cooling Method	Passive Air
Standard Warranty (months)	6
MTTF (operational hours)	6000
Weight of Laser Head (kg)	0.26
Laser Head Dimensions (mm)	68 (l) x 20 (d)
Power Supply	3-6 VDC input

CW: All specifications are based on performance at full output power and after the specified warmup period. Output characteristics may change if the laser is run at a different power level.

Q-Switched: Specifications are based on the laser pulsing at the specified design frequency. Output characteristics may change if the laser is run at a different frequency.

Power Supply Options:

The Brightline Premium series of alignment lasers accept direct DC input of 3 to 6 VDC. The power connector is a 5.5 mm OD, 2.1 mm ID DC Barrel Jack (center pole positive), but non-waterproof connectors are compatible. If you do not want to provide DC current directly, we recommend that you use our AC power supply. The model number for the standard North American AC Power Supply is ABF05AWXX and you can find complete details here:

www.laserglow.com/ABF.

Projection Types:

The following projection types are available for this laser series.

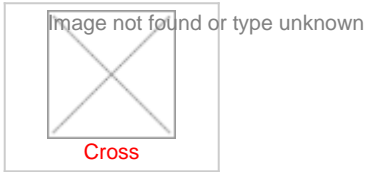

Regulatory Classification:

The model you have selected (BCH005342) requires the following safety label(s):



Dimensional Drawing - Laser Form Factor: B9:





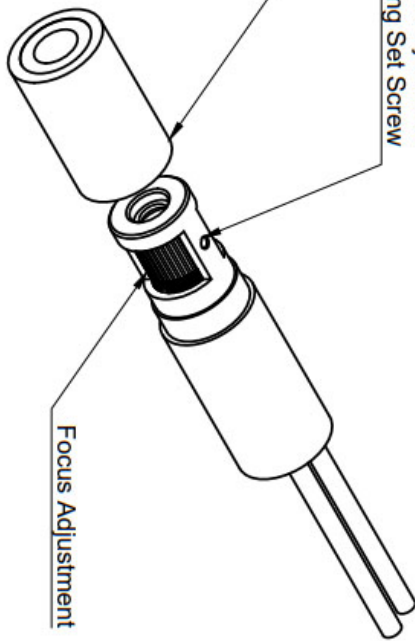



Remove front cap to
access focus adjustment



Title	
Brightline Premium	
Laserglow Technologies	
Dimensions are in mm [inch]	
The information contained in this drawing is the sole property of Laserglow Technologies. Any reproduction in part or as a whole without the written permission of Laserglow Technologies is Prohibited.	
Rev.	

Accessories:

The most popular accessories for model BCH005342 are shown below. For additional details regarding these or other accessories please see our website or contact us directly.

Part Number	Description	
 ADB000XXX	ADB-deluxe Brightline Deluxe Mounting Bracket Full Details: www.laserglow.com/ADB	Included With Laser
 ABB000XXX	ABB-standard Brightline Standard Mounting Bracket Full Details: www.laserglow.com/ABB	
 ABC2SPXXX	2 Lead Brightline Splitter Cable Full Details: www.laserglow.com/ABC	
 ABC4SPXXX	4 Lead Brightline Splitter Cable Full Details: www.laserglow.com/ABC	
 ABC72EXXX	6 Foot Brightline Power Extension Cable Full Details: www.laserglow.com/ABC	
 ABF05A2XX	ABF-N.American Brightline Premium 5V Power Supply (80-260 VAC, N. American plug) 2 Amp Special Order For Brightline Premium Only Full Details: www.laserglow.com/ABF	Included With Laser
 ABLATTXXX	Brightline Attenuator c/w Optics Full Details: www.laserglow.com/ABL	

FOR MORE INFORMATION PLEASE CONTACT:

LASERGLow TECHNOLOGIES
873 St. Clair Ave West, Toronto, ON, Canada M6C1C4
Tel. (416) 729-7976 Fax (480) 247-4864
sales@laserglow.com www.laserglow.com

E&OE: Data included in this sheet may be subject to change without notice.

Please confirm critical specifications with our staff prior to ordering.