

## LBD-635 Brightline Pro Dot-Projecting Laser

**Laserglow Part Number:  
BDP005XXX**

### Similar Products:

For information about the other lasers in this product family visit:

<http://www.laserglow.com/BDP>

### Ordering:

Order Online Now or Request Quote:

<http://www.laserglow.com/BDP005XXX>

### Series Specifications:

Nominal Wavelength	635 nm
Output Type	CW
Laser Source Type	Diode



### Overview:

Laserglow's dot-generating laser modules will provide you with a quick reference point for any alignment application. The Brightline Pro Red Dot generating laser modules incorporate focus-adjustable optics, greatly increasing the precision for tasks requiring a higher level of accuracy or greater working distance.

### Key Features:

- *Starting at: \$209*
- *Output Power: 5 mW*
- *Expected Life: 3000-5000 hours*
- *Projection Type (dot/line/cross): Dot*
- *Key Feature: Projects a focus-adjustable red dot for high precision applications.*
- *Minimum achievable spot size: 0.5 mm at 30 cm*
- *Package Includes: Alignment laser mounted in block (mounting bracket, attenuator and power supply optional)*
- *Casing: Machined Aluminum*

## Specifications:

This spec sheet has been generated specifically for part number BDP005XXX, per your request, and data for the entire series is also displayed for your reference. The specs which are specific to BDP005XXX have been highlighted below in **red + bold**.

Laser Form Factor	<b>B3</b>
Output Power (mW)	<b>&lt;5</b>
Output Power Stability (%RMS/4h)	<b>&lt;20</b>
IEC Safety Class	<b>3R</b>
Projection Type (See below for detail)	<b>Dot</b>
Divergence (mrad, full angle)	<b>&lt;0.3</b>
Beam Dimensions (mm, 1/e <sup>2</sup> )	<b>7</b>
Minimum Achievable Beam Diameter	<b>0.5 mm at 0.3 m</b>
Transverse Mode	<b>Near TEM00</b>
Longitudinal Modes	<b>Multiple</b>
Operating Temperature Range (°C)	<b>-10 to 40</b>
Max. TTL Modulation Freq. (Hz)	<b>200</b>
Modulation Input Signal	<b>0-5 VDC</b>
Total Power Consumption (W)	<b>1</b>
Max. Power Input Duty Cycle	<b>100%</b>
Cooling Method	<b>Passive Air</b>
Standard Warranty (months)	<b>6</b>
MTTF (operational hours)	<b>5000</b>
Weight of Product or Laser Head (kg)	<b>0.1</b>
Dimensions of Product or Laser Head (mm)	<b>73 (l) x 20 (d)</b>
Power Supply	<b>3.0 VDC input</b>

CW: All specifications are based on performance at full output power and after the specified warmup period. Output characteristics may change if the laser is run at a different power level.

Q-Switched: Specifications are based on the laser pulsing at the specified design frequency. Output characteristics may change if the laser is run at a different frequency.

### Power Supply Options:

The Brightline Economy and Brightline Pro series of alignment lasers accept direct DC input of 3.0 VDC. The power connector is a 5.5 mm OD, 2.1 mm ID DC Barrel Jack. (center pole positive.) If you do not want to provide DC current directly, we recommend that you use our AC power supply. The model number for the standard North American AC Power Supply is ABP00AFXX and you can find complete details here: [www.laserglow.com/ABP](http://www.laserglow.com/ABP). The dimensional drawing for the standard power supply is included on page 5 for your reference.

### Regulatory Classification:

The model you have selected (BDP005XXX) requires the following safety label(s):



LASERGLOW.COM LIMITED, 873 St. Clair Ave W, Toronto, ON, Canada M6C 1C4

**Dimensional Drawing - Laser Form Factor: B3:**

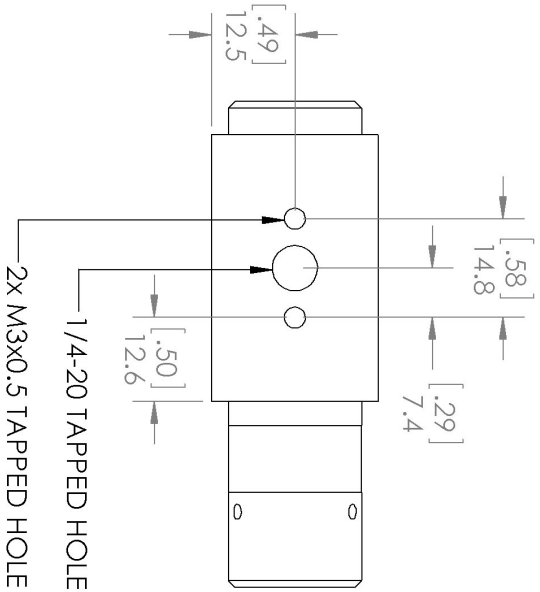
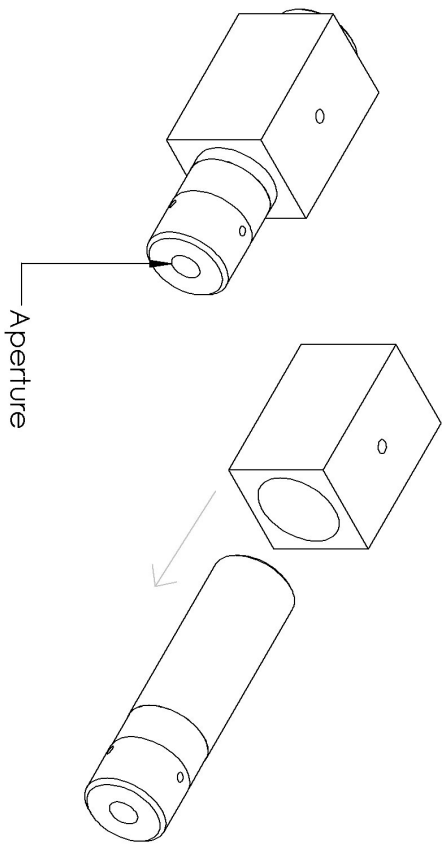
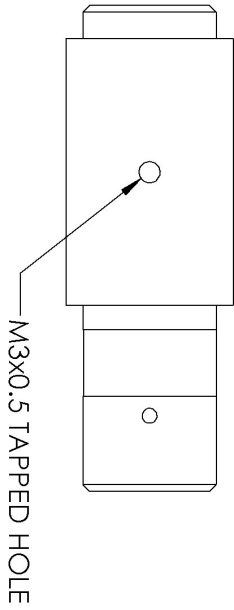
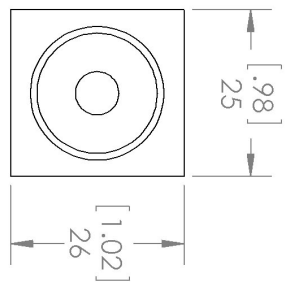
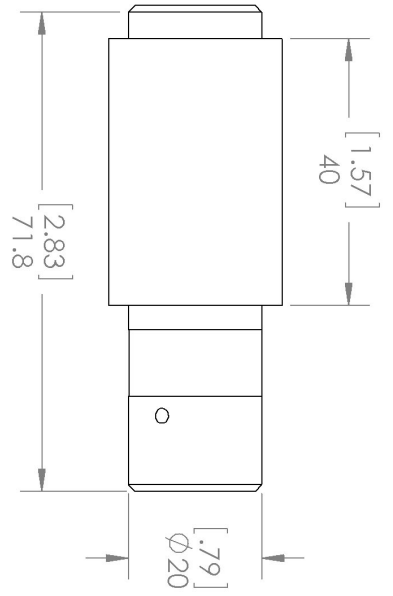



UNLESS OTHERWISE SPECIFIED:  
 DIMENSIONS ARE IN MILLIMETER  
 TOLERANCES: +/- 0.075 MM

THE INFORMATION CONTAINED IN THIS  
 DRAWING IS THE SOLE PROPERTY OF  
 LASERGLLOW TECHNOLOGIES. ANY  
 REPRODUCTION IN PART OR AS A WHOLE  
 WITHOUT THE WRITTEN PERMISSION OF  
 LASERGLLOW TECHNOLOGIES IS  
 PROHIBITED. © 2012 LASERGLLOW.COM  
 LIMITED. ALL RIGHTS RESERVED

Laserglow Technologies		
TITLE:		
<b>Brightline                  Form Factor                  B3</b>		
REV 1		
SCALE: 1:1		SHEET 1 OF 1

**Accessories:**

The most popular accessories for model BDP005XXX are shown below. For additional details regarding these or other accessories please see our website or contact us directly.

Part Number	Description	
 ADB002XXX	ADB-deluxe Brightline Deluxe Mounting Bracket V2 Full Details: <a href="http://www.laserglow.com/ADB">www.laserglow.com/ADB</a>	Included With Laser
 ABF00AXXX	ABF-N.American Brightline 3V Standard Power Supply (80-260 VAC, N. American plug) Full Details: <a href="http://www.laserglow.com/ABF">www.laserglow.com/ABF</a>	Included With Laser
 ABC2SPXXX	2 Lead Brightline Splitter Cable Full Details: <a href="http://www.laserglow.com/ABC">www.laserglow.com/ABC</a>	

**FOR MORE INFORMATION PLEASE CONTACT:**

LASERGLOW TECHNOLOGIES  
99 Ingram Dr. Unit B, North York, ON, Canada M6M2L7  
Tel. (416) 729-7976 Fax (716) 322-3510  
[sales@laserglow.com](mailto:sales@laserglow.com) [www.laserglow.com](http://www.laserglow.com)

E&OE: Data included in this sheet may be subject to change without notice.

Please confirm critical specifications with our staff prior to ordering.