

## Brightline Premium Line-Projecting Laser

**Laserglow Part Number: BLQ005281**

### Similar Products:

For information about the other lasers in this product family visit:

<http://www.laserglow.com/BLQ>

### Ordering:

Order Online Now or Request Quote:

<http://www.laserglow.com/BLQ005281>

### Series Specifications:

Nominal Wavelength	635 nm
Output Type	CW
Laser Source Type	Diode



### Overview:

The Brightline Premium Series of Lasers are ideal for any application where highly visible projections, such as lines, dots, crosses, complex patterns, need to be projected onto a surface. These diode lasers are designed to withstand day to day use in harsh industrial environment. The waterproof aluminum and brass housing protect the laser diode, electronic circuitry and precision optics. These lasers incorporate focus-adjustable optics, greatly increasing the precision for tasks requiring the highest level of accuracy or greater working distance.

### Key Features:

- Output Power: Up to 80 mW
- IEC Safety Classification: 3R (no additional safety eyewear required)
- Minimum achievable spot/line size: 25 mm at 30 cm
- Package Includes: Laser mounted in block, adjustable mounting bracket for easy positioning of projection onto a surface, and 110/240V AC power supply
- Available Projection Colors: Red, Green, Blue, Violet
- Projection Type: Line, Dot, Cross
- Casing: Machined Aluminum anodized Red
- Water Resistant: IP67
- Operating Temperature Range: 0° to 120°F (-20°C to 50°C)
- Operating Life: 8,000+ hours of continuous use

## Specifications:

This spec sheet has been generated specifically for part number BLQ005281, per your request, and data for the entire series is also displayed for your reference. The specs which are specific to BLQ005281 have been highlighted below in **red + bold**.

Laser Form Factor	<b>B9</b>
Output Power (mW)	<b>5, 20, 40, &gt;60, &gt;80</b>
Output Power Stability (%RMS/4h)	<10
IEC Safety Class	2, <b>3R</b>
Projection Type (See below for detail)	Line Line (DOE #227) Line (DOE #266) Line (DOE #283) Line (DOE #287) Line No Central Dot (DOE #267) Line No Central Dot (DOE #286) <b>Line of 11 dots (DOE #281)</b> Line of 5 dots (DOE #263)
Projection Fan Angle (°, full angle)	5, 6, <b>17</b> , 20, 30, 37, 41, 44, 90
Divergence (mrad, full angle)	<b>&lt;0.3</b>
Beam Dimensions (mm, 1/e <sup>2</sup> )	<b>7</b>
Minimum Achievable Beam Diameter	<b>0.25 mm at 0.3 m</b>
Transverse Mode	<b>Near TEM00</b>
Longitudinal Modes	<b>Multiple</b>
IP rating	<b>67</b>
Operating Temperature Range (°C)	<b>-20 to 50</b>
Storage Temperature Range (°C)	<b>-20 to 50</b>
Max. TTL Modulation Freq. (Hz)	<b>500</b>
Modulation Input Signal	<b>0-5 VDC</b>
Total Power Consumption (W)	<b>1</b>
Max. Power Input Duty Cycle	<b>100</b>
Cooling Method	<b>Passive Air</b>
Standard Warranty (months)	<b>6</b>
MTTF (operational hours)	<b>6000</b>
Weight of Product or Laser Head (kg)	<b>0.26</b>
Dimensions of Product or Laser Head (mm)	<b>68 (l) x 20 (d)</b>
Power Supply	<b>3-6 VDC input</b>

CW: All specifications are based on performance at full output power and after the specified warmup period. Output characteristics may change if the laser is run at a different power level.

Q-Switched: Specifications are based on the laser pulsing at the specified design frequency. Output characteristics may change if the laser is run at a different frequency.

## Power Supply Options:

The Brightline Premium series of alignment lasers accept direct DC input of 3 to 6 VDC. The power connector is a 5.5 mm OD, 2.1 mm ID DC Barrel Jack (center pole positive), but non-waterproof connectors are compatible. If you do not want to provide DC current directly, we recommend that you use our AC power supply. The model number for the standard North American AC Power Supply is ABF05AWXX and you can find complete details here:

[www.laserglow.com/ABF](http://www.laserglow.com/ABF).

## Projection Types:

The following projection types are available for this laser series.

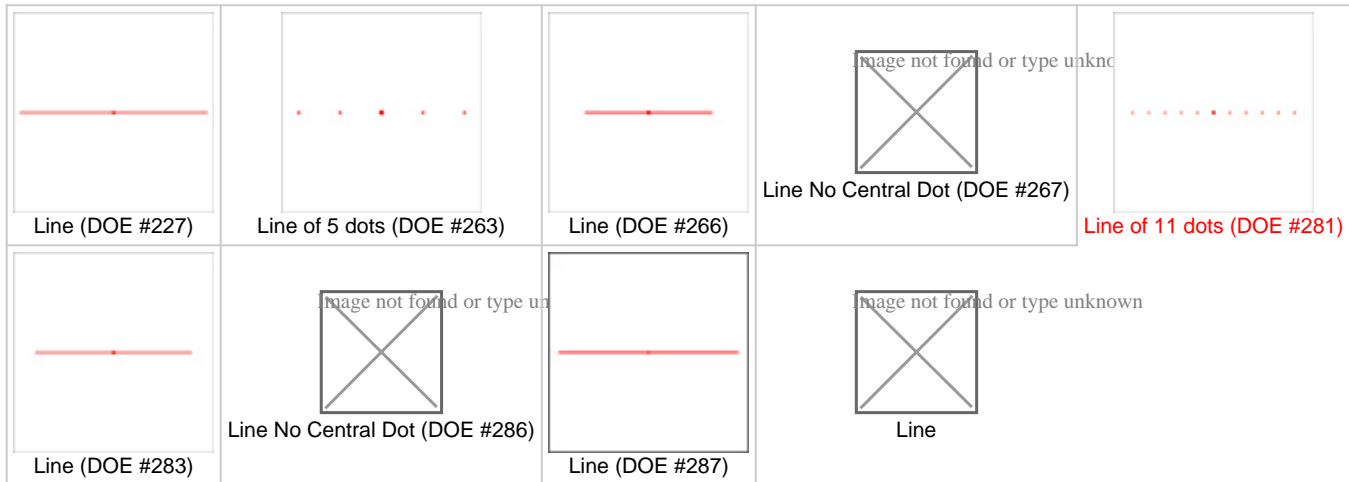

## Regulatory Classification:

The model you have selected (BLQ005281) requires the following safety label(s):



Dimensional Drawing - Laser Form Factor: B9:





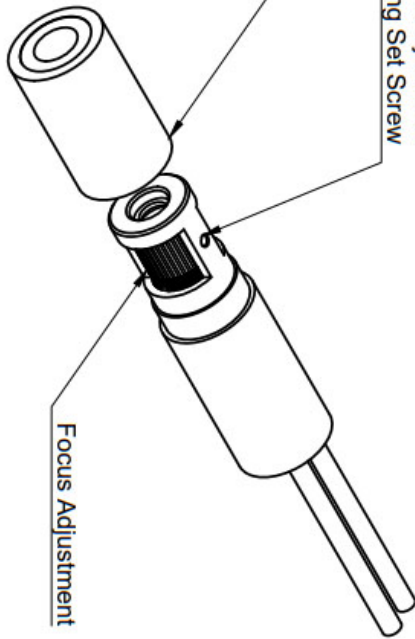



Remove front cap to  
access focus adjustment



Title	
<b>Brightline Premium</b>	
Laserglow Technologies	
Dimensions are in mm [inch]	
The information contained in this drawing is the sole property of Laserglow Technologies. Any reproduction in part or as a whole without the written permission of Laserglow Technologies is Prohibited.	
Rev.	

## Accessories:

The most popular accessories for model BLQ005281 are shown below. For additional details regarding these or other accessories please see our website or contact us directly.

Part Number	Description	
 ABB000XXX	ABB-standard Brightline Standard Mounting Bracket Full Details: <a href="http://www.laserglow.com/ABB">www.laserglow.com/ABB</a>	
 ABC2SPXXX	2 Lead Brightline Splitter Cable Full Details: <a href="http://www.laserglow.com/ABC">www.laserglow.com/ABC</a>	
 ABC4SPXXX	4 Lead Brightline Splitter Cable Full Details: <a href="http://www.laserglow.com/ABC">www.laserglow.com/ABC</a>	
 ABC72EXXX	6 Foot Brightline Power Extension Cable Full Details: <a href="http://www.laserglow.com/ABC">www.laserglow.com/ABC</a>	
 ABF05A3WX	ABF-N.American Brightline Premium 5V Power Supply (80-260 VAC, N. American plug) 3A w/WP connector For Brightline Premium Only Full Details: <a href="http://www.laserglow.com/ABF">www.laserglow.com/ABF</a>	Included With Laser
 ABLATTXXX	Brightline Attenuator c/w Optics Full Details: <a href="http://www.laserglow.com/ABL">www.laserglow.com/ABL</a>	
 ADB000XXX	ADB-deluxe Brightline Deluxe Mounting Bracket Full Details: <a href="http://www.laserglow.com/ADB">www.laserglow.com/ADB</a>	Included With Laser

## FOR MORE INFORMATION PLEASE CONTACT:

LASERGLOW TECHNOLOGIES  
99 Ingram Dr. Unit B, North York, ON, Canada M6M2L7  
Tel. (416) 729-7976 Fax (716) 322-3510  
[sales@laserglow.com](mailto:sales@laserglow.com) [www.laserglow.com](http://www.laserglow.com)

E&OE: Data included in this sheet may be subject to change without notice.

Please confirm critical specifications with our staff prior to ordering.