

## LBD-635 Brightline Economy Line-Projecting Laser

**Laserglow Part Number:  
BLR0050XX**

### Similar Products:

For information about the other lasers in this product family visit:

<http://www.laserglow.com/BLR>

### Ordering:

Order Online Now or Request Quote:

<http://www.laserglow.com/BLR0050XX>

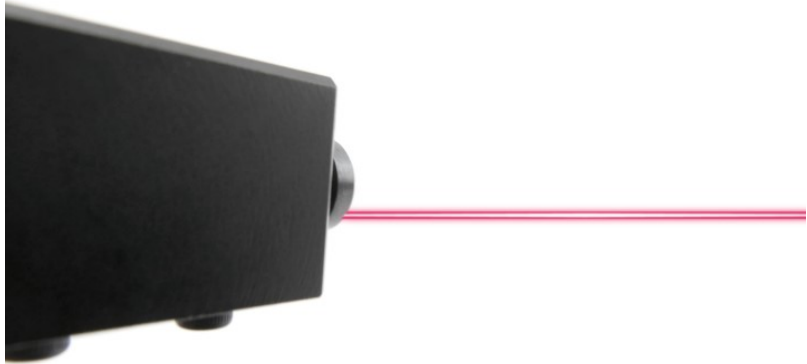

### Series Specifications:

Nominal Wavelength	635 nm
Output Type	CW
Laser Source Type	Diode

### Overview:

Laserglow's line-generating laser modules are ideal for any application where a highly visible line projected on to a surface is needed. Laser modules are available in 10, 30 or 100 degree fan angles, determining the projected line length at a given distance. The Brightline Series Red Line generating laser modules are an economical solution for tasks requiring a moderate level of precision.

### Key Features:

- *Starting at: \$139*
- *Output Power: 5 mW*
- *Expected Life: 3000-5000 hours*
- *Projection Type (dot/line/cross): Line*
- *Key Feature: Projects red line at an economical price.*
- *Casing: Machined Aluminum*
- *Package Includes: Laser module, aluminum casing with tripod mount, plastic carrying case, instructions/warranty (standard power supply and mounting bracket included).*
- *Line Straightness: Better than 0.1% over full length*

### Applications:

- LumberLine Lasers & Stone Cutting Lasers
- Saw Lasers
- Rip saw lasers
- Band Saw Lasers
- Bridge Saw Lasers
- Stone Cutting Lasers
- Laser Docking System For Trucks & Trailers
- Truck Lasers
- Vison Lasers
- Laser crosshair generator
- Torch machine laser crosshairs

- Safety Hazard Zone Projection

## Specifications:

This spec sheet has been generated specifically for part number BLR0050XX, per your request, and data for the entire series is also displayed for your reference. The specs which are specific to BLR0050XX have been highlighted below in **red + bold**.

Laser Form Factor	<b>B6</b>
Output Power (mW)	<b>&lt;5</b>
Output Power Stability (%RMS/4h)	<b>&lt;20</b>
IEC Safety Class	<b>2</b>
Projection Type (See below for detail)	<b>Line (Cylindrical Lens CYL)</b>
Projection Fan Angle (°, full angle)	<b>100</b>
Divergence (mrad, full angle)	<b>&lt;1</b>
Beam Dimensions (mm, 1/e <sup>2</sup> )	<b>4</b>
Transverse Mode	<b>Near TEM00</b>
Longitudinal Modes	<b>Multiple</b>
Operating Temperature Range (°C)	<b>-10 to 40</b>
Total Power Consumption (W)	<b>1</b>
Max. Power Input Duty Cycle	<b>100%</b>
Cooling Method	<b>Passive Air</b>
Standard Warranty (months)	<b>6</b>
MTTF (operational hours)	<b>5000</b>
Weight of Product or Laser Head (kg)	<b>0.1</b>
Dimensions of Product or Laser Head (mm)	<b>32 (l) x 12 (d)</b>
Power Supply	<b>3.0 VDC input</b>

CW: All specifications are based on performance at full output power and after the specified warmup period. Output characteristics may change if the laser is run at a different power level.

Q-Switched: Specifications are based on the laser pulsing at the specified design frequency. Output characteristics may change if the laser is run at a different frequency.

### Power Supply Options:

The Brightline Economy and Brightline Pro series of alignment lasers accept direct DC input of 3.0 VDC. The power connector is a 5.5 mm OD, 2.1 mm ID DC Barrel Jack. (center pole positive.) If you do not want to provide DC current directly, we recommend that you use our AC power supply. The model number for the standard North American AC Power Supply is ABP00AFX and you can find complete details here: [www.laserglow.com/ABP](http://www.laserglow.com/ABP). The dimensional drawing for the standard power supply is included on page 5 for your reference.

### Regulatory Classification:

The model you have selected (BLR0050XX) requires the following safety label(s):



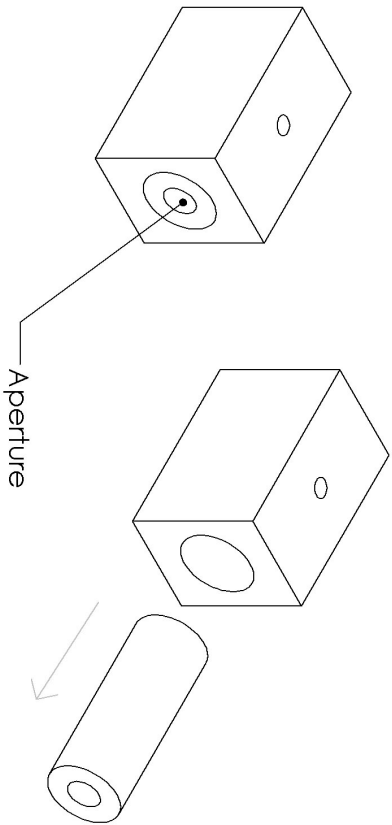
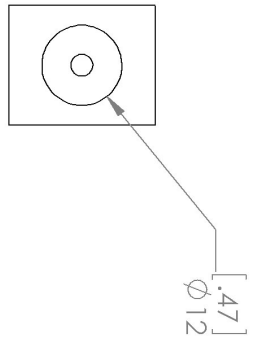
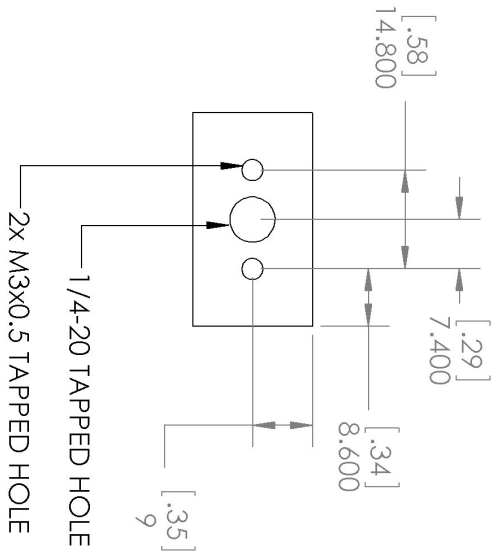
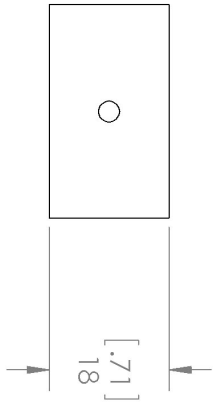
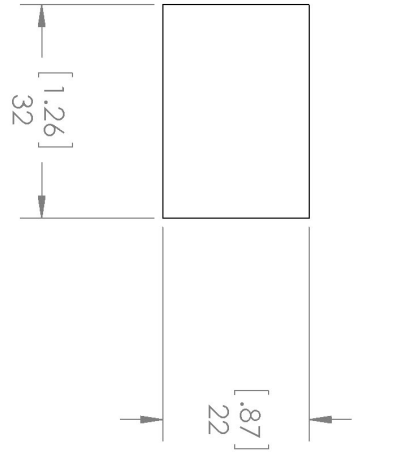

**Dimensional Drawing - Laser Form Factor: B6:**



<p><b>Laserglow Technologies</b></p>	
<p><b>TITLE:</b></p> <p><b>Brightline</b></p> <p><b>Form Factor B6</b></p>	
<p>UNLESS OTHERWISE SPECIFIED:                  DIMENSIONS ARE IN MILLINCH                  TOLERANCES: +/- 0.075 MM</p>	
<p>THE INFORMATION CONTAINED IN THIS                  DRAWING IS THE SOLE PROPERTY OF                  LASERGLLOW TECHNOLOGIES. ANY                  REPRODUCTION IN PART OR AS A WHOLE                  WITHOUT THE WRITTEN PERMISSION OF                  LASERGLLOW TECHNOLOGIES IS                  PROHIBITED. © 2012 LASERGLLOW.COM                  LIMITED. ALL RIGHTS RESERVED</p>	
<p>SCALE: 1:1</p>	<p>SHEET 1 OF 1</p>
<p>REV 1</p>	

**Accessories:**

The most popular accessories for model BLR0050XX are shown below. For additional details regarding these or other accessories please see our website or contact us directly.

Part Number	Description	
 ADB002XXX	ADB-deluxe Brightline Deluxe Mounting Bracket V2 Full Details: <a href="http://www.laserglow.com/ADB">www.laserglow.com/ADB</a>	Included With Laser
 ABF00AXXX	ABF-N.American Brightline 3V Standard Power Supply (80-260 VAC, N. American plug) Full Details: <a href="http://www.laserglow.com/ABF">www.laserglow.com/ABF</a>	Included With Laser

**FOR MORE INFORMATION PLEASE CONTACT:**

LASERGLOW TECHNOLOGIES  
99 Ingram Dr. Unit B, North York, ON, Canada M6M2L7  
Tel. (416) 729-7976 Fax (716) 322-3510  
[sales@laserglow.com](mailto:sales@laserglow.com) [www.laserglow.com](http://www.laserglow.com)

E&OE: Data included in this sheet may be subject to change without notice.

Please confirm critical specifications with our staff prior to ordering.