

Laserglow Product Datasheet

Brightline Premium Complex Pattern Projecting Laser

Laserglow Part Number: BOH005259

Similar Products:

For information about the other lasers in this product family visit:

<http://www.laserglow.com/BOH>

Ordering:

Order Online Now or Request Quote:

<http://www.laserglow.com/BOH005259>

Series Specifications:

| | |
|--------------------|--------|
| Nominal Wavelength | 520 nm |
| Output Type | CW |
| Laser Source Type | Diode |



Overview:

Specifications:

This spec sheet has been generated specifically for part number BOH005259, per your request, and data for the entire series is also displayed for your reference. The specs which are specific to BOH005259 have been highlighted below in **red + bold**.

| | |
|--|---|
| Laser Form Factor | B9 |
| Output Power (mW) | 5 , 20, 40, 60 |
| IEC Safety Class | 2 , 3R |
| Projection Type (See below for detail) | 25 Parallel Lines (DOE #254) 5 Concentric Circles (DOE #259) 5 Parallel Lines (DOE #252) Circle of 72 Dots (DOE #221) Circle with Central Dot (DOE #219) Grid of Dots 101x101 (DOE #231) Grid of Dots 51x51 (DOE #257) Grid of Squares 50x50 (DOE #256) Reticle (DOE #260) Reticle of Dots (DOE #261) |
| Projection Fan Angle (°, full angle) | 4, 5, 14, 18, 21, 22, 24 , 28 |
| Divergence (mrad, full angle) | <0.3 |
| Beam Dimensions (mm, 1/e ²) | 7 |
| Minimum Achievable Beam Diameter | 0.25 mm at 0.3 m |
| Longitudinal Modes | Multiple |
| IP rating | 67 |
| Storage Temperature Range (°C) | -20 to 50 |
| Max. TTL Modulation Freq. (Hz) | 500 |
| Modulation Input Signal | 0-5 VDC |
| Total Power Consumption (W) | 1 |
| Max. Power Input Duty Cycle | 100 |
| Cooling Method | Passive Air |
| Standard Warranty (months) | 6 |
| MTTF (operational hours) | 6000 |
| Weight of Product or Laser Head (kg) | 0.26 |
| Dimensions of Product or Laser Head (mm) | 68 (l) x 20 (d) |
| Power Supply | 3-6 VDC input |

CW: All specifications are based on performance at full output power and after the specified warmup period. Output characteristics may change if the laser is run at a different power level.

Q-Switched: Specifications are based on the laser pulsing at the specified design frequency. Output characteristics may change if the laser is run at a different frequency.

Power Supply Options:

The Brightline Premium series of alignment lasers accept direct DC input of 3 to 6 VDC. The power connector is a 5.5 mm OD, 2.1 mm ID DC Barrel Jack (center pole positive), but non-waterproof connectors are compatible. If you do not want to provide DC current directly, we recommend that you use our AC power supply. The model number for the standard North American AC Power Supply is ABF05AWXX and you can find complete details here:

www.laserglow.com/ABF.

Projection Types:

The following projection types are available for this laser series.

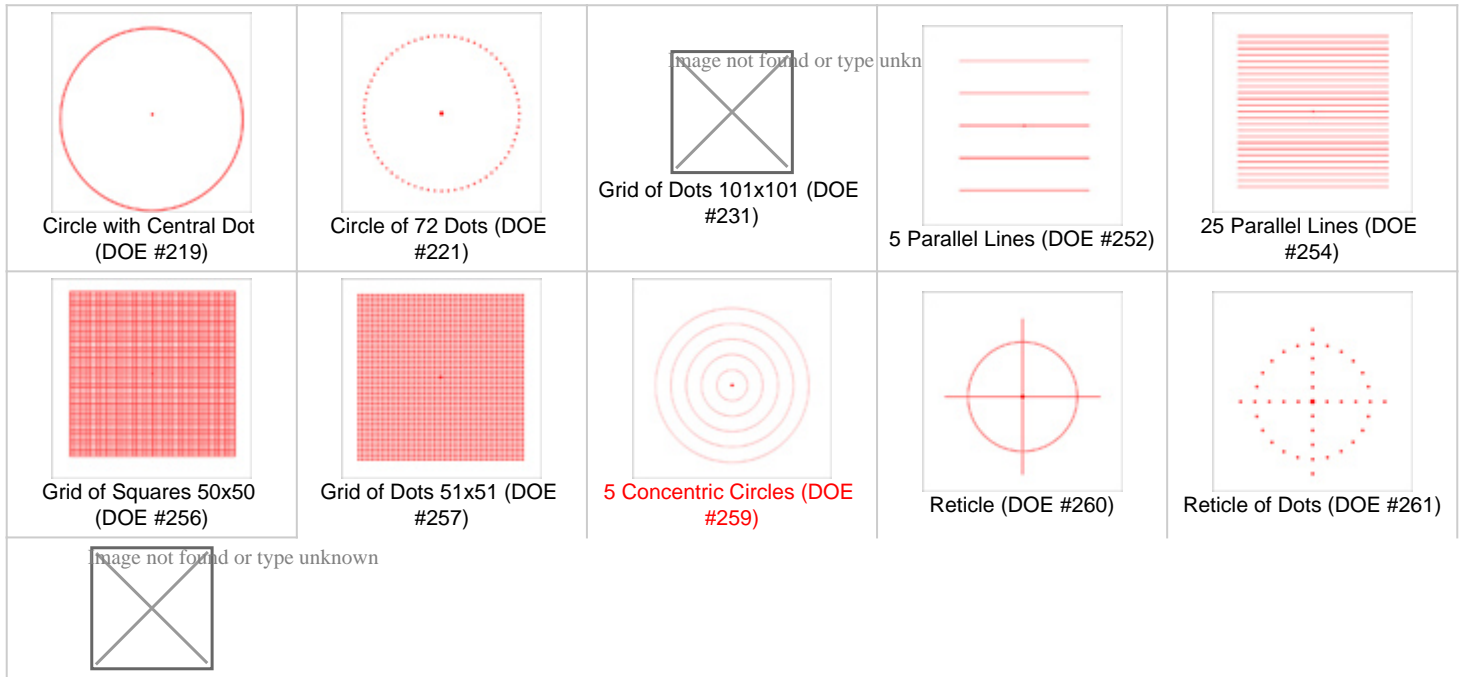

Regulatory Classification:

The model you have selected (BOH005259) requires the following safety label(s):



Dimensional Drawing - Laser Form Factor: B9:





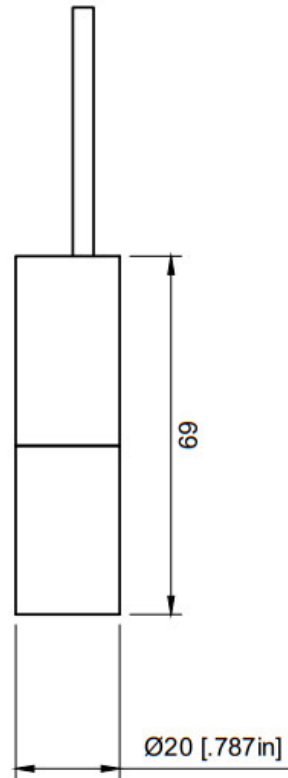
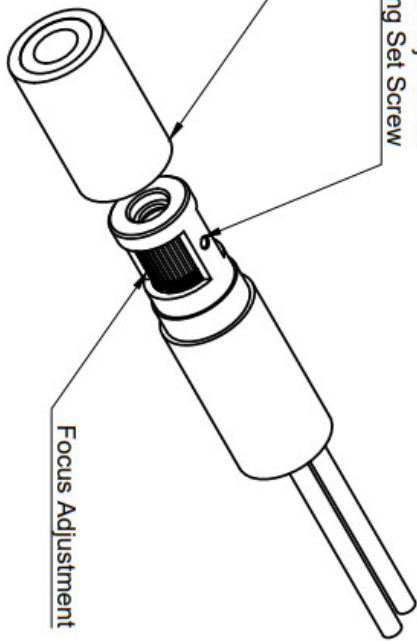



Remove front cap to
access focus adjustment



| | |
|---|--|
| Title | |
| Brightline Premium | |
| Laserglow Technologies | |
| Dimensions are in mm [inch] | |
| <small>The information contained in this drawing is the sole property of Laserglow Technologies. Any reproduction in part or as a whole without the written permission of Laserglow Technologies is Prohibited.</small> | |
| Rev. | |

Accessories:

The most popular accessories for model BOH005259 are shown below. For additional details regarding these or other accessories please see our website or contact us directly.

| Part Number | Description | |
|--|---|---------------------|
|  ADB000XXX | ADB-deluxe Brightline Deluxe Mounting Bracket Full Details: www.laserglow.com/ADB | Included With Laser |
|  ABB000XXX | ABB-standard Brightline Standard Mounting Bracket Full Details: www.laserglow.com/ABB | |
|  ABC2SPXXX | 2 Lead Brightline Splitter Cable Full Details: www.laserglow.com/ABC | |
|  ABC72EXXX | 6 Foot Brightline Power Extension Cable Full Details: www.laserglow.com/ABC | |
|  ABF05A3WX | ABF-N.American Brightline Premium 5V Power Supply (80-260 VAC, N. American plug) 3A w/WP connector For Brightline Premium Only Full Details: www.laserglow.com/ABF | Included With Laser |
|  ABLATTXXX | Brightline Attenuator c/w Optics Full Details: www.laserglow.com/ABL | |

FOR MORE INFORMATION PLEASE CONTACT:

LASERGLOW TECHNOLOGIES
99 Ingram Dr. Unit B, North York, ON, Canada M6M2L7
Tel. (416) 729-7976 Fax (716) 322-3510
sales@laserglow.com www.laserglow.com

E&OE: Data included in this sheet may be subject to change without notice.

Please confirm critical specifications with our staff prior to ordering.