

Hydra Blue Laser Pointer

Laserglow Part Number:
GHP005XXX



Similar Products:

For information about the other lasers in this product family visit:

<http://www.laserglow.com/GHP>

Ordering:

Order Online Now or Request Quote:

<http://www.laserglow.com/GHP005XXX>

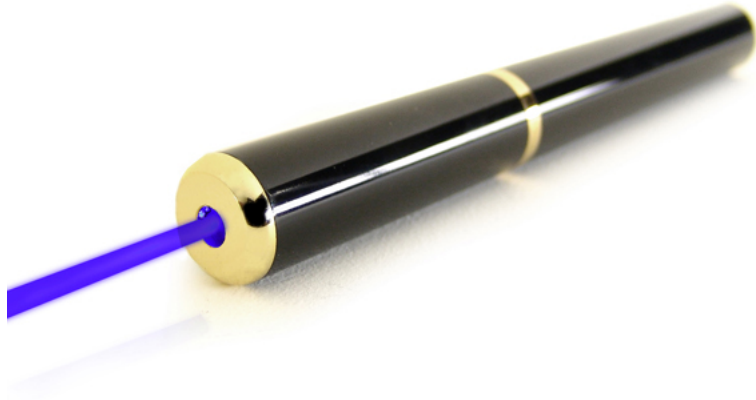

Series Specifications:

Nominal Wavelength	447 nm
Output Type	CW
Laser Source Type	Diode

Overview:

Cutting-edge 447 nm laser diode technology is what makes this blue laser pointer both unique and affordable. Keep everyone's attention with the Hydra's deep blue light. This 5 mW Class IIIa laser pointer is non-hazardous for momentary accidental exposure making it ideal in general business, school and home settings. Its ground breaking 447 nm wavelength is not only captivating but can also produce fluorescence effects in some materials. A wide operating temperature range, enhanced beam quality and low divergence result in maximum visibility. Diode technology means energy efficiency, allowing this laser to operate three times as long as DPSS blue laser pointers. Both beautiful and practical the Hydra Blue Laser Pointer is sure to impress.

Key Features:

- *Starting at: \$279*
- *Output Power:* 2 mW - 4.99 mW (Varies with model)
- *Expected Life:* 5000 hours
- *Wavelength:* 447 nm (blue)
- *Key Feature:* Cutting-edge laser diode technology in an affordable blue laser pointer!
- *Package Includes:* Laser pointer, aluminum carrying case, instructions/warranty.
- *Casing:* Piano-black finished Brass with gold accents
- *Safety Info:* Complies with Class IIIa regulations
- *Duty Cycle:* 100%

Specifications:

This spec sheet has been generated specifically for part number GHP005XXX, per your request, and data for the entire series is also displayed for your reference. The specs which are specific to GHP005XXX have been highlighted below in **red + bold**.

Laser Form Factor	GAP
Output Power (mW)	<5
FDA Safety Class	IIIa
Central Wavelength (nm)	447
Wavelength Tolerance (+/- nm)	5
Divergence (mrad, full angle)	<1.5
Beam Dimensions (mm, 1/e ²)	5
Transverse Mode	Near TEM00
Longitudinal Modes	Multiple
Approximate Peak Power (W)	5
Operating Temperature Range (°C)	-5 to 40
Storage Temperature Range (°C)	-10 to 50
Total Power Consumption (W)	1
Max. Power Input Duty Cycle	100%
Cooling Method	Passive Air
Standard Warranty (months)	6
MTTF (operational hours)	5000
Weight of Product or Laser Head (kg)	0.1
Dimensions of Product or Laser Head (mm)	150 (l) x 16.5 (d)
Power Supply	2 x CR2 Batteries

CW: All specifications are based on performance at full output power and after the specified warmup period. Output characteristics may change if the laser is run at a different power level.

Q-Switched: Specifications are based on the laser pulsing at the specified design frequency. Output characteristics may change if the laser is run at a different frequency.

Regulatory Classification:

The model you have selected (GHP005XXX) requires the following safety label(s):



Dimensional Drawing - Laser Form Factor: GAP:

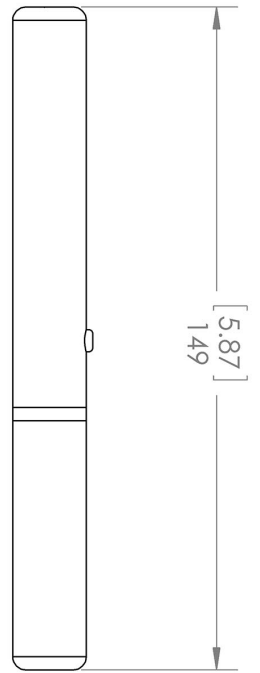
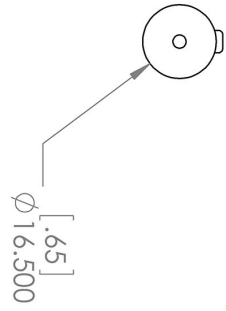
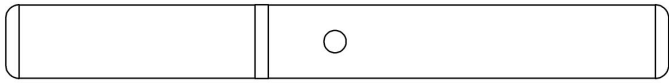

Aperture

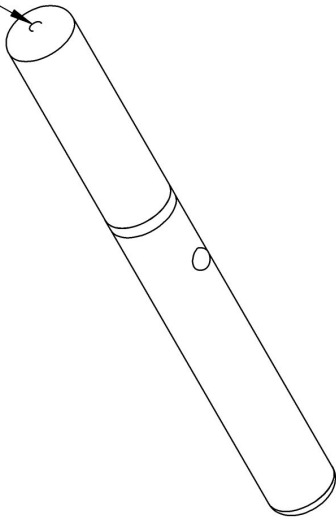

UNLESS OTHERWISE SPECIFIED:
DIMENSIONS ARE IN MM(INCH)
TOLERANCES: +/- 0.75 MM

THE INFORMATION CONTAINED IN THIS
DRAWING IS THE SOLE PROPERTY OF
LASERGLLOW TECHNOLOGIES. ANY
REPRODUCTION IN PART OR AS A WHOLE
WITHOUT THE WRITTEN PERMISSION OF
LASERGLLOW TECHNOLOGIES IS
PROHIBITED. © 2012 LASERGLLOW.COM
LIMITED. ALL RIGHTS RESERVED

Laserglow Technologies



TITLE:
**Aquarius /
Rigel HV /
Electra / Hydra**
REV
1

SCALE: 2:3

SHEET 1 OF 1

Accessories:

The most popular accessories for model GHP005XXX are shown below. For additional details regarding these or other accessories please see our website or contact us directly.

Part Number	Description	
 ACAGAQ1XX	Carrying Case-7 Aquarius/Electra/Rigel HV/Hydra Full Details: www.laserglow.com/ACA	Included With Laser
 ACAGAQ1XX	Carrying Case-7 Aquarius/Electra/Rigel HV/Hydra Full Details: www.laserglow.com/ACA	Included With Laser

FOR MORE INFORMATION PLEASE CONTACT:

LASERGLOW TECHNOLOGIES
99 Ingram Dr. Unit B, North York, ON, Canada M6M2L7
Tel. (416) 729-7976 Fax (716) 322-3510
sales@laserglow.com www.laserglow.com

E&OE: Data included in this sheet may be subject to change without notice.

Please confirm critical specifications with our staff prior to ordering.